

The Drive of Choice for Highest Demands

Reliable, precise, and durable.



ROBICON Perfect Harmony

Answers for industry.

SIEMENS

ROBICON Perfect Harmony

The Perfect Harmony of Performance and Value



According to energy authorities, industrial motors consume over a billion kilowatt hours of energy each year – fully 50 percent of the world’s energy usage. System enhancements such as improved sizing and proper matching to load, more efficient drive trains, and adjustable speed drives will help drive energy usage down, according to experts. That means that the right drive can help you drive cost out of your operation by providing more precise and efficient control of motors, fans, pumps, and other devices.

If your process includes motors, fans, or pumps and you haven’t installed a drive yet, you’re letting thousands of dollars of energy costs eat away at your bottom line every month because of process inefficiencies.

Siemens drives, the best-selling medium-voltage AC drives in the world, deliver an impressive combination of benefits:

- Lower operating costs
- Precise process control
- Lower maintenance costs
- Increased production efficiency
- Exceptional reliability
- Intuitive HMI

The ROBICON Perfect Harmony’s outstanding record has made it the drive of choice for demanding applications that require the highest levels of reliability, precision, and longevity. Employed in applications ranging from power generation to oil and gas, water, marine, and paper production, the ROBICON Perfect Harmony drive is a versatile performer that can help you significantly increase productivity, enhance energy efficiency, and reduce operating costs.



Siemens can provide a custom-engineered ROBICON Perfect Harmony drive to maximize your process. We're the only company that offers drives from 225 to 120,000 kW. And with an installed base exceeding more than 2.2 million kW worldwide, the ROBICON Perfect Harmony is a proven workhorse that can perform brilliantly for you, too.

A Bright Future Built on a Firm Foundation

Since its introduction in 1994, the ROBICON Perfect Harmony drive has revolutionized power conversion and continues to set industry standards for reliability and innovation. As power switching device technology advances and increases output voltage capability, Siemens improves each generation of the ROBICON Perfect Harmony in three key areas: increased reliability and availability, increased efficiency, and a smaller drive footprint.

Advances to our product line are made without "reinventing the wheel" like other drive manufacturers. We have maintained the ROBICON Perfect Harmony's core topology and continue to advance its capability, ensuring life-cycle product support. By keeping the same topology, our customers see a reduction in maintenance and spare parts as well as an increase in quality and lower life-cycle costs. We improve our products by actively soliciting the input of our customers, and we look forward to counting you among them.

The ROBICON Perfect Harmony of today represents an evolution founded on experience garnered from our huge installed base coupled with Siemens' unparalleled investments in R&D. As one of the largest companies in the world, Siemens provides confidence and financial stability in addition to exceptional technology. We offer you expertise across the globe and a world of innovation.

Designed for Maximum Versatility, Efficiency, and Reliability

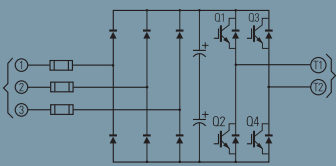

Power Cell

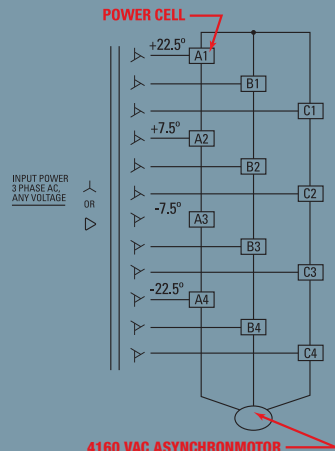

4160 VOLT DRIVE TOPOLOGY

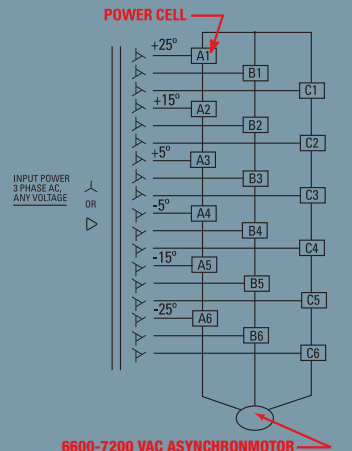

6600-7200 VOLT DRIVE TOPOLOGY



Different by Design

The patented, integrated design of the ROBICON Perfect Harmony drive ensures a level of reliability, efficiency, and versatility that is unmatched in the power controls industry. The ROBICON Perfect Harmony is designed to withstand failures that would overwhelm conventional drive systems.

A traditional drive features up to five separate components, such as harmonic filter, power factor correction, transformer, power converter, and motor filter. The ROBICON Perfect Harmony's topology isolation transformer and power converter are the only major components required.

The integrated system allows for quick, easy, and less expensive installations and start-ups – shortening your outages and process downtime to give you more project flexibility.

In the ROBICON Perfect Harmony, a series of low-voltage cells are linked together to build the medium-voltage power output of the drive system. This patented configuration delivers for you when it comes to ease of maintenance, power quality, and reliability. It also provides the basis for one of its most important advantages – increased availability through the advanced cell bypass option.

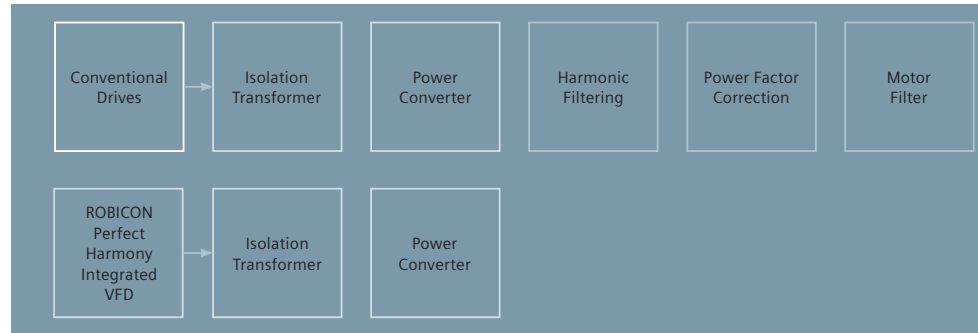

System Performance

The ROBICON Perfect Harmony exceeds .95 power factor at normal operating speeds without external power-factor correction capacitors. It also provides more than 98 percent power converter efficiency and 97 to 96.5 percent total drive system efficiency.

Load (%)	Drive Efficiency (%)	Total Drive System Efficiency (%) (Drive & Transformer)	Power Factor
25	97.5 – 93.4	97.0 – 96.5	.96
50	98.0 – 95.0	97.2 – 96.8	.96
75	98.5 – 97.5	97.2 – 96.8	.96
100	98.6 – 98.0	97.0 – 96.5	.95

Efficiency and power factor values are based on centrifugal load characteristics for torque and speed.

Versatility

The proven technology of ROBICON Perfect Harmony drives meets the needs of customers in almost any industry that employs motors, fans, or pumps. The ROBICON Perfect Harmony drive can accept many different input voltages and can provide motor output voltages up to 13,800 volts, putting it in a class by itself. And with a life expectancy of 25 years, the ROBICON Perfect Harmony lets you set it and forget it. The rewards pile up as the years pass by.

When it comes to retrofits, the ROBICON Perfect Harmony upholds its reputation as the world’s most versatile medium-voltage drive.

The ROBICON Perfect Harmony is compatible with your existing motor systems, regardless of age, brand, or voltage/frequency – even synchronous motors can be upgraded.

You can be sure that the ROBICON Perfect Harmony is compatible with your power system because it meets the most stringent IEEE 519 1992 requirements for current harmonic distortion. We meet those guidelines without filter or harmonic mitigation equipment – the ROBICON Perfect Harmony design includes a transformer that employs phase shifting technology to eliminate harmonic distortion at the source.

Efficiency

The integrated ROBICON Perfect Harmony maximizes efficiency in a number of critical areas. Because systems seldom require 100 percent power, the variable drive provides only the necessary power to the motor. As demands increase or decrease, the drive can respond with the precise power level needed.

One of the most inefficient power events occurs at motor start-up. Typically, a motor “slams” on – going from off to 100 percent with the flick of a switch. By contrast, the “soft start” features of the ROBICON Perfect Harmony decrease stresses that can limit the life of your equipment – gradually increasing power to smoothly initiate power output with full rated torque available during acceleration from zero speed, but without any current inrush into the motor. Additionally, overall design integration helps provide quick and reliable start-ups and allows the addition of power conversion redundancy. Pre-wiring reduces installation costs as well. It all adds up to give you a smaller, more efficient and reliable system.

Clean Power Input

Harmonic Comparison

ROBICON Perfect Harmony Series vs. Typical 12-pulse PWM Inverter (100KVA, 5.75% Impedance Source)

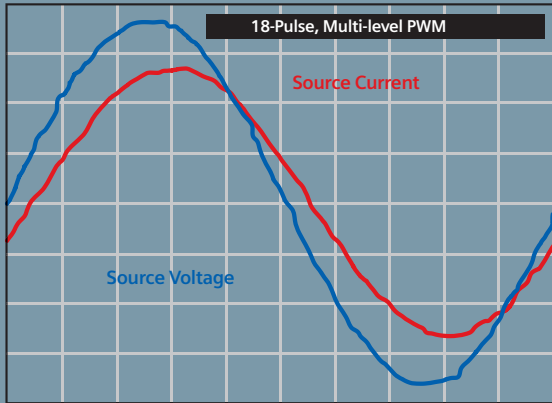

- ROBICON Perfect Harmony Series Waveform
- less than 3% total voltage distortion
 - less than 5% total current distortion
 - Meets IEEE 519-1992 at the input to the isolation transformer

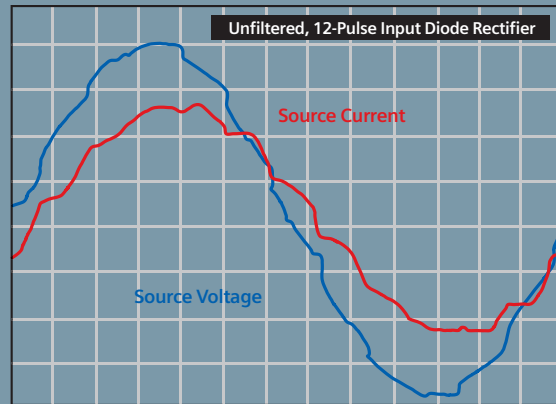

- 12-Pulse Harmonic Waveform
- 5.9% total voltage distortion
 - 8.8% total current distortion

Measured Power Factor

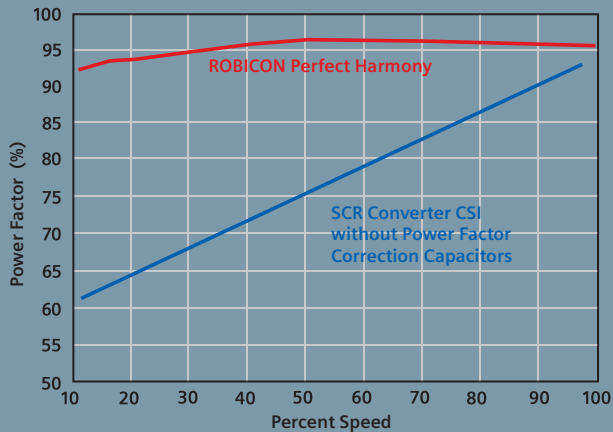

Total power factor includes distortion and displacement power factor.

Typical System Efficiency

ROBICON Perfect Harmony Series vs. CSI PWM or LCI

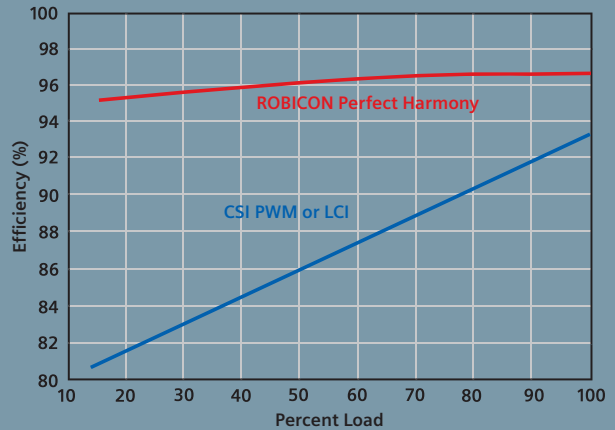

System efficiency includes isolation transformer, harmonic filter, power factor correction, and drive.

The ROBICON Perfect Harmony drive meets the most stringent harmonic requirements for voltage and current distortion:

- Protects other on-line equipment from harmonic disturbance (computers, telephones, lighting ballast, and other power converters)
- Avoids costly and inefficient harmonic filters and associated resonance problems

Power Quality Output



ROBICON Perfect Harmony
Output Waveforms at 100% Speed

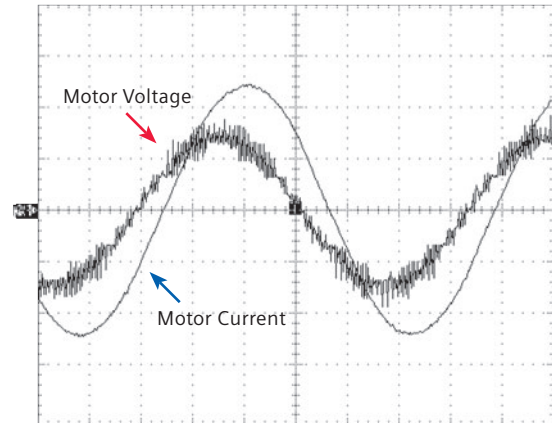

ROBICON Perfect Harmony
Output Waveforms at 50% Speed

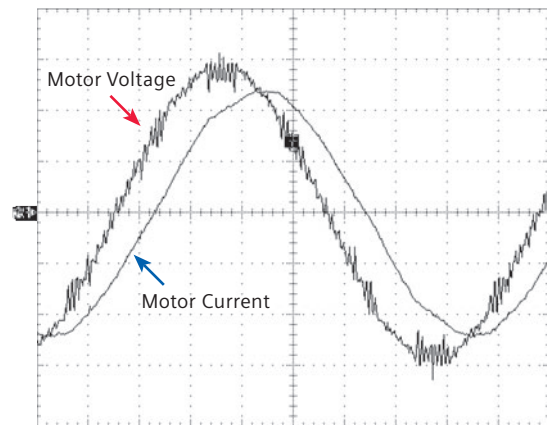

Multi-Level, Pulse-Width Modulated,
Output-Voltage Waveform

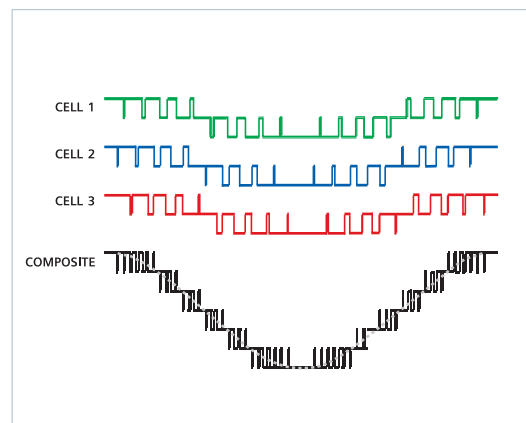

- Integrated transformer
 - Eliminates common mode motor insulation stress
 - Isolation transformer is integral component of ROBICON Perfect Harmony
 - Motor no longer requires additional insulation
- Drive is compatible with new and existing 1.0 or higher service factors of induction and synchronous motors
- Smooth operation: no significant drive-induced torque pulsations, even at low speeds, thus eliminating expensive flexible couplings
- Cool under pressure: no additional drive-induced motor heating
- Versatile and flexible installation – No cable length restrictions; isolation transformer is integrated into the drive
- Works with standard motor insulation

Maximized Availability

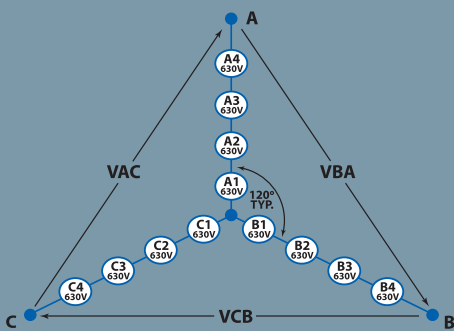

Equivalent Circuit of 4-Cell Generation³ ROBICON Perfect Harmony Drive with all cells in service
 • 4160 Volts Type. (Line-to-Line)

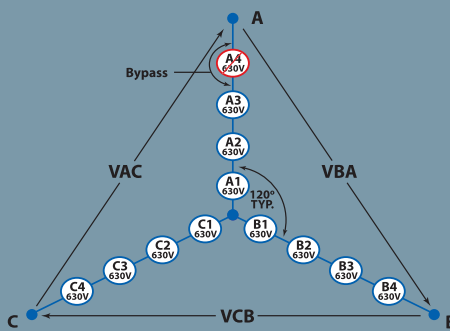

Equivalent Circuit of 4-Cell ROBICON Perfect Harmony Drive with Cell A4 out of service
 • Unbalance after loss of A4 (not acceptable)

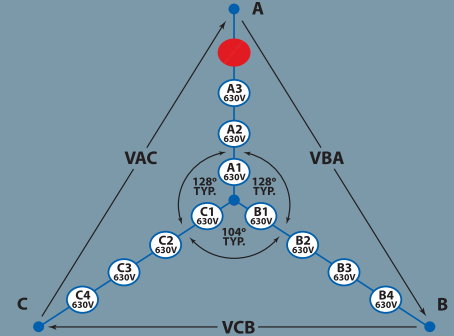

Equivalent Circuit of 4-Cell ROBICON Perfect Harmony Drive with Cell A4 out of service
 • Neutral Point Shift: Balance Restored after loss of A4 by adjusting angles. Maximum Voltage = $87.5\% \times 4440V = 3850V$

Reliability

The reliability and availability of the ROBICON Perfect Harmony drive is second to none due to sophisticated component selection and design. A combination of industry-proven components, redundant bypass control technology, and hierarchical system of warnings brings you a drive of uncompromising prowess.

Insulated Gate Bipolar Transistors

Traction-grade Insulated Gate Bipolar Transistors (IGBTs) form the backbone of the ROBICON Perfect Harmony drive. A proven power device across the industrial power control industry, IGBT technology has been in existence for more than a decade. The stability and availability of IGBTs give you reliable, long-term, life-cycle confidence. But that's just the start of our forward-thinking design.

Advanced Cell Bypass

The ROBICON Perfect Harmony is engineered to withstand failures that would overwhelm conventional drives because we've added redundancy options into the system. Our patented, cell-based configuration maximizes uptime and simplifies modifications.

Through a redundant bypass control that is completely separated from each power cell, the ROBICON Perfect Harmony ensures automatic bypass of a failed power cell in 450 milliseconds (less than 1/2 of a second).

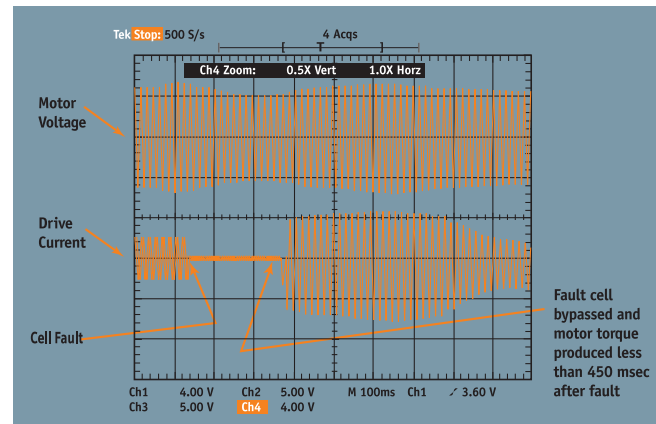
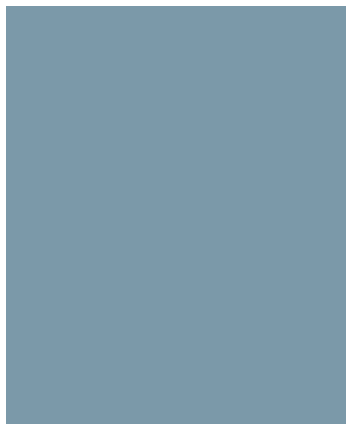

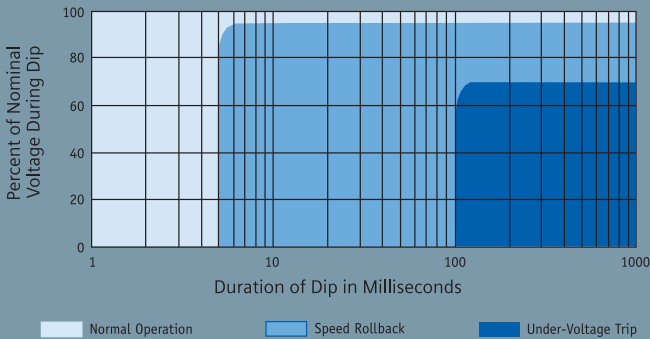

Voltage Dip Withstand Capability During Full Load, Nominal Voltage

The ROBICON Perfect Harmony operates continuously, even during a 30 percent voltage dip.



ProTOPS

Another feature that enhances the ROBICON Perfect Harmony’s reliability is its control strategy. Our Process Tolerant Protection Strategy (ProToPS™) is a groundbreaking process control system available exclusively from Siemens. Instead of tripping the drive and automatically shutting down the system due to a malfunction, ProToPS gives you a hierarchical system of warnings. This control strategy allows time to evaluate the situation and respond appropriately to avoid a system shutdown. ProToPS has proven invaluable for many of our ROBICON Perfect Harmony customers, including strategic power plants, refineries, water and wastewater facilities, and process plants. With additional response time and early warnings, your operators can diagnose and correct problems and maintain uninterrupted production.

Get up and Running Fast



Factory System Test

You can be confident that the ROBICON Perfect Harmony will get your process up and running because we have the ability to test every product as a complete system at full load – prior to delivery. At our factory, we test every transformer and power converter together to ensure performance meets precise specifications. In addition, factory testing allows accurate efficiency measurements. We also verify sequence of operation and protection to ensure that the ROBICON Perfect Harmony system matches your needs.

Easy Setup and Control

- Easy-to-use high-function keypad on the door
- Touch-screen interface on door also available
- Auto-tune feature shortens start-up and guarantees operational efficiency
- Drive tool runs on PCs that can interface through the RS 485 or Ethernet ports that are standard
- Other protocols supported:
 - Modbus Plus™
 - DeviceNet Profile 12™
 - ControlNet™
 - PROFIBUS DP™
 - Other connectivity as required by the user

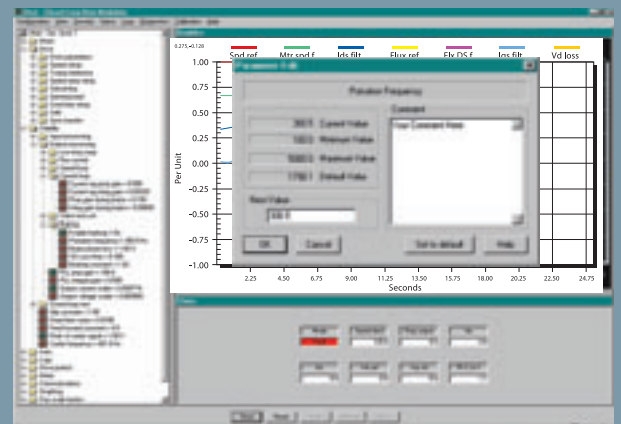
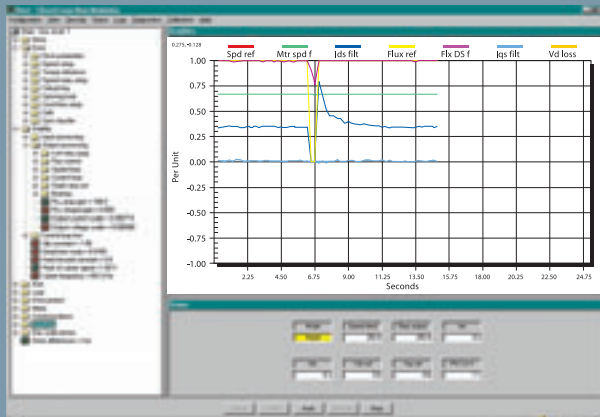

Control Drive Tool

- Provides Windows-based graphical user interface
- Has full functionality
- Same menu structure as keypad interface

Options add versatility to your ROBICON Perfect Harmony drive. It is available with forced-air cooling (left) or self-contained, closed-loop, water cooling (far left). Redundant pumps are standard on water-cooled units. Redundant blowers are a standard option for air-cooled units.

The multi-cell design allows quick rack in/ out of power cells, making maintenance of the ROBICON Perfect Harmony simple. A hydraulic "cell lifter cart" is an option for larger cell designs.



Protecting Your Investment



From your first meeting with Siemens, you'll notice the difference. Our experts have tailored thousands of systems, so we have the experience to help you select the right drives for your process. From initial specification through production, delivery, and installation, we are wholly committed to your satisfaction.



You have a lot at stake and, as the world's foremost automation company, so do we. That's why Siemens' service and support network is never more than a phone call away. Representatives are ready 24 hours a day, seven days a week, to assist you with immediate technical support geared to handle every phase of installation, start-up, maintenance, and troubleshooting.

Our services include:

- Around-the-clock field service 24/7/365
- Preventive maintenance
- Training
- After-market spare parts
- Product refurbishment
- Upgrades
- Repairs and exchanges
- Specialty services (harmonic analysis studies, power quality studies, electrical system application, remote diagnostics, and more)

Our Commitment

Siemens is proud of our reputation for long-term service of our products, including the ROBICON Perfect Harmony. We are committed to providing complete life-cycle support. We never relinquish the responsibility for servicing our products to your full satisfaction, regardless of the age of the product. To extend the life span and increase the functionality of the drive, the Siemens refurbishment program gives you the opportunity to upgrade ROBICON Perfect Harmony drives with new technology as it becomes available.

Local Convenience

Because we have long provided on-site service for all of our customers, we have the extensive reach of a dedicated, global service force. Each of our service representatives is fully trained.

Technical Specifications

General		Cooling Type	
Power semiconductors	IGBTs; diodes	Air-cooled	Forced-air cooling with integrated fans
Line-side converter	18- to 36-pulse diode rectifier (standard)	Permissible ambient and cooling temperature	
Motor-side converter	Multi-level converter (PWM) with IGBT power modules	– In operation	5°C to +40°C: 100% load capability +40°C to 50°C: current derating
Closed-loop control	Sensorless closed-loop control, fully digital with signal processor	– During storage	–5°C to +55°C
Drive quadrants	Driving: 2 directions of rotation (2 quadrants), 4-quadrant option	– During transport	–25°C to +70°C
Potential separation: Power section	Fiber-optic cable	Water-cooled	Deionized water with a choice of integrated water-to-water heat exchanger or an outside water-to-air heat exchanger
Permissible humidity rating	Relative air humidity < 95% noncondensing	Permissible ambient temperature	
Noise level	Below 78 dB (A)	– In operation	+5°C to +40°C
Efficiency (standard version)	Higher than 96% at the rated operating point including transformer	– During storage	–5°C to +55°C (without deionized water)
Regulations compliances	IEEE, ANSI, NEMA, UL, CSA, CE	– During transport	–25°C to +70°C (without deionized water)
Paint finish	ANSI 61 Gray	Permissible cooling temperature (raw water)	
Degree of protection	Acc. to DIN VDE 0470, IEC 60529, EN 60529	– Intake	+5°C to 35°C
– Standard	IP31 = NEMA1 (air-cooled) IP52 = NEMA12 (water-cooled)	Incoming Service	
– Optional	IP42 (air cooling)	Standard	2.3 to 13.8 kV
		Special option	Below 2.3 kV and above 13.8 kV
		Control voltage	1 Ph, 120 VAC or integrated to auxiliary supply
		Cooling	3 Ph, 480 VAC or other

Output Parameters

Rated Motor Voltage Single-Drive Configuration

2.3 kV		3.3 kV		4.16 kV		6.0 kV		6.6 kV		11 kV	
Output Current	Output kVA	Output Current	Output kVA	Output Current	Output kVA	Output Current	Output kVA	Output Current	Output kVA	Output Current	Output kVA
70	300	70	400	70	500	70	700	70	800	500	8000
100	400	100	600	100	700	100	1000	100	1000	800	15,000
140	500	140	800	140	1000	140	1500	140	1500	1400	25,000
200	800	200	1000	200	1500	200	2000	200	2000		
260	1000	260	1500	260	1750	260	2500	260	3000		
315	1250	315	1750	315	2000	315	3000	315	3500		
375	1500	375	2000	375	2500	375	4000	375	4000		
500	2000	500	2500	500	3500	500	5000	500	5500		
660	2500	660	3500	660	4500	660	7000	660	7500		
		880	5000	880	6500	880	9000	880	9500		
		1250	7000	1250	9000	1250	13,000	1250	14,000		
										13.8 kV	
										Output Current	Output kVA
										50	10,000
										800	18,000
										1400	31,000

Maximum output frequency – 330 Hz (with derating).
Speed-control range – 1:1000 (with encoder).

**ROBICON Perfect Harmony
In Synch with Your Business
Goals**

- Lower operating costs
- Precise process control
- Lower maintenance costs
- Increased production efficiency
- Exceptional reliability
- Intuitive HMI



Siemens AG
Industry Sector
Large Drives
P.O. Box 47 43
90025 NUREMBERG
GERMANY

Subject to change without prior notice
Order No. E20001-A10-P590-X-7600
Dispo 21503
21/7865 MK.LD.XX.SIGM.52.8.07 WS 03083.0
Printed in Germany
© Siemens AG 2008

www.siemens.com/robicon-perfect-harmony

The information provided in this brochure contains merely general descriptions or characteristics of performance which in actual case of use do not always apply as described or which may change as a result of further development of the products. An obligation to provide the respective characteristics shall only exist if expressly agreed in the terms of contract.

All product designations may be trademarks or product names of Siemens AG or supplier companies whose use by third parties for their own purposes could violate the rights of the owners.